

# LED Commercial Round High Bay with Wattage and CCT Selector

Project Name:	Order Number:	Prepare by:	Note:	Date:	Type:

**150-200-240 WATTS**

**The MUHB-150-200-240W-3CCT series**

Designed to replace the metal halide for both industrial and commercial applications. The UFO high bay fixture can be easily installed in most areas with a hook mount. It also features with a 1V to 10V dimming technology, allows you to complete control the light output. This unique fixture is built for durability and longevity with a weatherproof IP65 rating and a 50,000 hour life rating backed by a 5 year warranty. This product is DLC listed, it also promotes high-quality and energy efficient lighting products through vigorous testing protocols.



- Select color temperature from
- 3500K **NATURAL WHITE**
  - 4000K **COOL WHITE**
  - 5000K **DAYLIGHT**



## DIMENSION

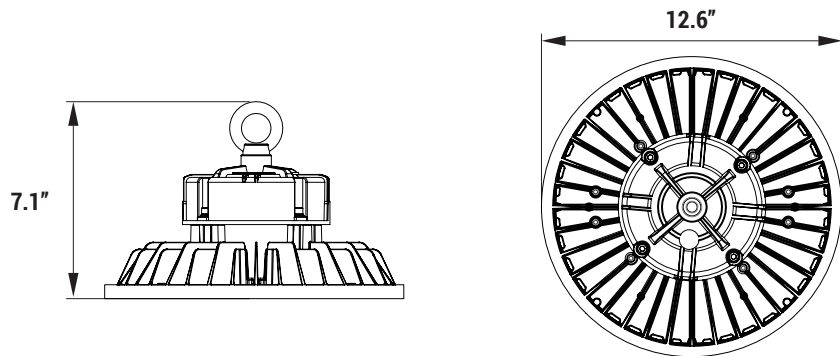

## TECHNICAL SUMMARY

LUMENS	WATTS	EFFICACY	CRI	VOLTAGE	BEAM °	CCT	PF	LIFE	OPERATING TEMP.
21000 28000 33600	150W 200W 240W	140 lm/W	70	120 to 277Vac 60Hz	140	3500K 4000K 5000K	>0.9	50,000 hrs	-4°F ~ 104°F

## PART NUMBER ORDERING SUMMARY

**I MUHB-150-200-240W-3CCT**



# LED Commercial Round High Bay with Wattage and CCT Selector

Project Name:	Order Number:	Prepare by:	Note:	Date:	Type:

## CONSTRUCTION

- Unit includes heavy duty metal frame, LED array, heat sink, hanger, security cable and high quality PC lens.

## OPTICS

- Diffuse for uniform illumination.
- CRI 70+

## DRIVER

- 120 - 277V 60Hz universal input voltage
- 0 - 10v smooth flicker free dimming down to 5%

## MOUNTING

Pendant mount to the ceiling

## LISTING

- DLC Listed
- UL 8750 LED equipment in Lighting Products

## WARRANTY

5 years manufacturer warranty, consult [www.mwledlighting.com](http://www.mwledlighting.com) for more details.

\* Terms and conditions may apply.

\*5 years limited LED luminaire warranty to the original purchaser that the luminaire shall be free from defects in materials and workmanship from date of shipment, when under properly installed at normal conditions of use. The warranty may not cover physical damage or abuse under certain conditions.

## HIGHLIGHT



### ADVANCED HEAT DISSIPATION TECHNOLOGY

Aluminum alloy body coated with black/white anti-corrosion coating surface for better realize heat radiation and heat dissipation.



### SENSOR SOCKET READY

Product comes with built-in sensor/ photocell socket for your convenience.

## ACCESSORIES (SOLD SEPARATELY)



Emergency Driver



Aluminium Reflector



PC Reflector



Hanging Hook



Bracket Installation Kits



Suspending Chains