

META Surface-Pendant

Spec-grade | Vertical Architectural LED Linear Lighting

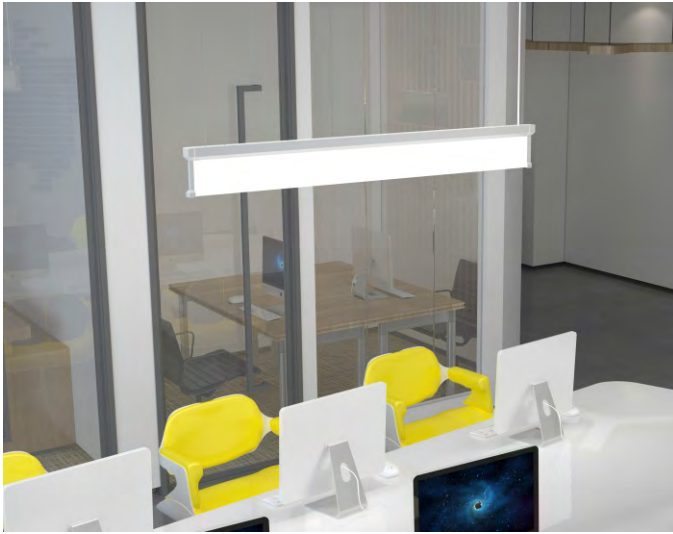

ILLUMINATING US



Our Meta Surface delivers precise, textural, and comfortable linear lighting for a variety of applications including pendant, surface and wall mount to suit your daily needs. It is integrated with ultra-thin semi-transparent vertical optics, enveloped in a signature sloping silhouette where the frame meets the optics. It appears to be floating in the air, creating a comfortable and distinctive direct/indirect luminaire.

With wattage selectable and CCT adjustable function, Meta Surface also has the flexibility to illuminate many types of spaces, packing a powerful punch of up to 1600 lumen per foot with 90+CRI.



Feature

- 3 lengths & sloping silhouette
- Transparent optics
- Wattage selectable, up to 1600 lm/ft
- True color, 90+CRI
- CCT adjustable from 3000K, 3500K and 4000K

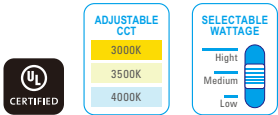

*DesignLights Consortium Qualified and classified for DLC standard / premium, refer to www.designlights.org for details

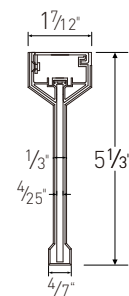

PERFORMANCE

Model#	Length	Lumen Package			
		Wattage	3000K	3500K(DLC Qualification)	4000K(DLC Qualification)
LV4-ITW2F	2'	20W	1150lm/ft, 115lm/w	1250lm/ft, 125lm/w	1200lm/ft, 120lm/w
LV4-ITW3F	3'	20W/30W/40W Selectable	750-1500lm/ft, 115lm/w	800-1650lm/ft, 125lm/w	800-1600lm/ft, 120lm/w
LV4-ITW4F	4'	20W/30W/40W Selectable	550-1150lm/ft, 115lm/w	600-1250lm/ft, 125lm/w	600-1200lm/ft, 120lm/w

*All efficacy is ±5% base on different CCT. Check the IES file to gain the accurate data.

META Surface-Pendant

Spec-grade | Vertical Architectural LED Linear Lighting



ILLUMINATING US

PRODUCT ORDERING GUIDE

Example: LV4-ITW2F (Pendant)

LV4	I	TW		(Pendant)
Product Series	Driver	CCT	Length & Wattage	Just to remark the mounting. Don't show in product label.
LV4 Meta Surface Linear	I Internal Driver	TW CCT Adjustable 3000K/3500K/4000K	2F 2 Feet,20W QuickShip	
			3F 3 Feet,20W/30W/40W Selectable QuickShip	
			4F 4 Feet,20W/30W/40W Selectable QuickShip	

OPTIONAL PENDANT ACCESSORY

Ceiling Type	Canopy	Power Cord&Aircraft Cable	Optional Functions
DW QuickShip Dry ceiling Mount to J-box	RDWH QuickShip 1.6" Round & White 4.5" Round & White (Designed for power cable)	C05WH QuickShip 4 ft white power cord + 5ft aircraft cable	EME QuickShip Emergency Function (Only external 8w or 25w LED emergency driver with standard indicator available and need field-installed.)
TF QuickShip Drop ceiling clips for 9/16" and 15/16" flat ceiling	SQWH QuickShip 1.6" Square & White 4.5" Square & White (Designed for power cable)	C12WH 12 ft white power cord + 12ft aircraft cable	
TS QuickShip Drop ceiling clips for 9/16" slot ceiling	RDBL QuickShip 1.6" Round & Black 4.5" Round & Black (Designed for power cable)	C05BL QuickShip 4 ft black power cord + 5ft aircraft cable	OCC QuickShip Sensor Function (Built-in occupancy sensor in 5.8inch round canopy)
TX QuickShip Drop ceiling clips for 15/16" slot ceiling	SQBL QuickShip 1.6" Square & Black 4.5" Square & Black (Designed for power cable)	C12BL 12 ft black power cord + 12ft aircraft cable	

STRUCTURE

► Finish

Extruded aluminum housing with powder coat white finish or custom.

► Optics

Ultra-thin semi-transparent vertical optics, enveloped in a signature sloping silhouette where the frame meets the optics.

► Electrical

Mini Internal LED Driver It is powered by Class 2 high efficiency LED driver, with a standard 1-10V dimming which continuous dims to 10% that works with many types of controls. Tested Dimmers: Lutron® Diva-Dvtv, Leviton® IP-710-DL.

THD <20%

Power Factor >0.9

Input Voltage Standard electronic drivers are UL recognized and available for 110-277V or 110-347V AC* input voltage.

► LED System

CRI Minimum 90 color rendering index.

CCT CCT adjustable from 3000K, 3500K and 4000K with a great color consistency.

LED Minimum 50,000h with 87.8% of lumen maintenance in 25°C ambient temperature, in compliance with IES LM-80 testing measurements.

Environment Damp rated for ambient operating temperature of -20°C to +40°C [-4° to +104°F].

DIMENSIONS

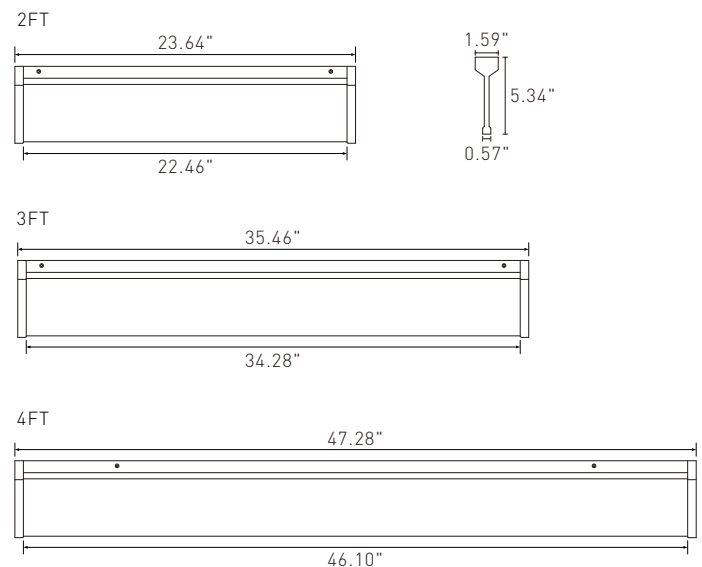

META Surface-Pendant

Spec-grade | Vertical Architectural LED Linear Lighting



ILLUMINATING US

MOUNTING

Canopy Style



1.6" Round
(Non Power Feed)

4.5" Round
(Power Feed)

4.5" Round With
Emergency Driver
(Non Power Feed)

5.8" Round With
Occupancy Sensor
(Power Feed)

1.6" Square
(Non Power Feed)

4.5" Square
(Power Feed)

4.5" Square With
Emergency Driver
(Non Power Feed)

Dry Ceiling / Off Grid

"Various Hard Ceilings" (Mount to J-box)

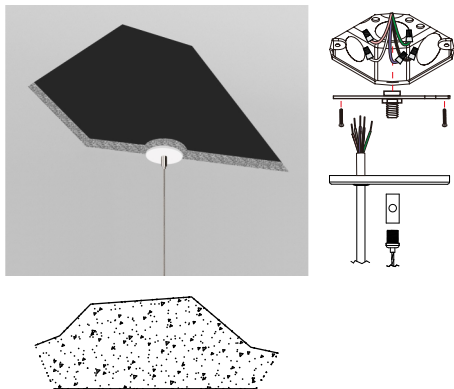

Drop Ceiling / On Grid

Suspending the luminaire in the T-grid. Compatible for various T-grid, including 9/16" Flat, 9/16" Slot, 15/16" Flat.

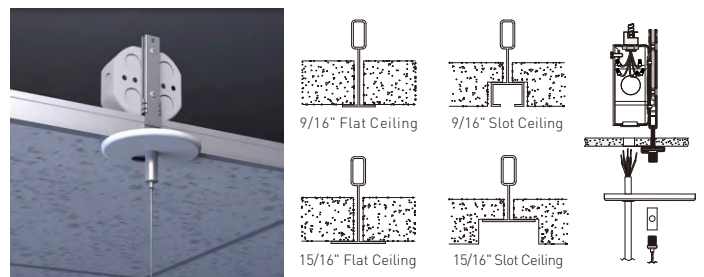

*Please see the installation instruction for more details.

Pendant Accessories For Dry Ceiling

Canopy Kits



Power Cord Kits



4FT Standard
(12FT Available)

Aircraft Cable Kits



5FT Standard
(12FT Available)

Pendant Accessories For Drop Ceiling

Canopy Kits



Junction Box



Power Cord Kits



4FT Standard
(12FT Available)

Aircraft Cable Kits



5FT Standard
(12FT Available)

T-grid Clips



For 9/16" and 15/16"
Flat Ceiling
(2 Clips/Set)



For 9/16" Slot Ceiling
(2 Clips/Set)



For 15/16" Slot Ceiling
(2 Clips/Set)

META Surface-Pendant

Spec-grade | Vertical Architectural LED Linear Lighting



OPTIONAL FUNCTION

► Emergency Option

IUS Lighting offers UL & CEC Listed LED emergency drivers. When AC power fails it, immediately switches to the emergency mode operating for lighting minimum 90 minutes. When AC power is restored it, automatically returns to the charging mode which meets critical life-safety lighting requirements.



Order Separated LED emergency driver

Optional 8w or 25w high voltage LED emergency driver can be provided if you need and do it wiring in field. For more ir or spec sheet please visit our, website or contact sales.



Code-Required Testing

• Initial Self-Test After Installation

It will perform a functional test in 3 seconds after the driver installed to check the wiring and battery output when work. The indicator LED will be off or flicker in case of a failure or an error.

• Second Self-Test In 120 Minutes

It will perform second test in 120 minutes to check again. Upgrade in Gen 3: Repeat 4 times in every 120 minutes if fail in the second test.

• Monthly Self-Test

It will automatically perform a test every 30 days with a duration of 3 seconds, in which the wiring and battery output are checked. In case of a failure or an error, the indicator LED will be off or flicker.

► Occupancy Sensor



We can provide a factory-installed integrated sensor system for multi-level control based on motion and/or daylight contribution with BRI810-B-D level & daylight harvest microwave sensor from SHARKWARD. For more info or spec sheet, please contact sales.



Specification

Power Supply	120/277 VAC 50/60Hz
Maximum load (@-40°F~+158°F (-40°C~+70°C))	Resistive/ Tungsten-600W@120V Electronic Ballast(LED)-800VA@120V/1200VA@277V
HF System	5.8GHz CW
Dim Control Output	0-10V, max.25mA sinking current
Detection Radius/angle	Max 26ft.(8m)/360
Mounting Height	Max 12ft
Humidity	Max.95% RH
Temperature	-40°F~+158°F (-40°C~+70°C)

Sensor Coverage

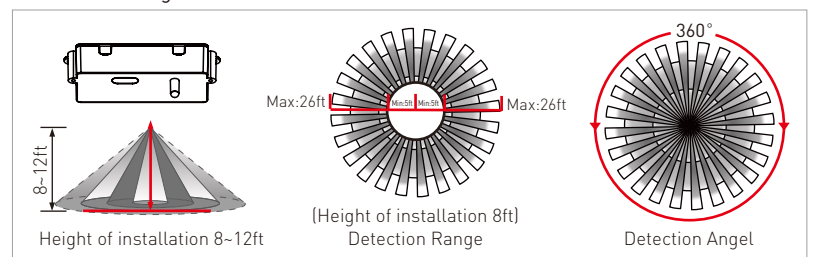

META Surface-Pendant

Spec-grade | Vertical Architectural LED Linear Lighting



DISTRIBUTION DIAGRAM

2' / 3500K

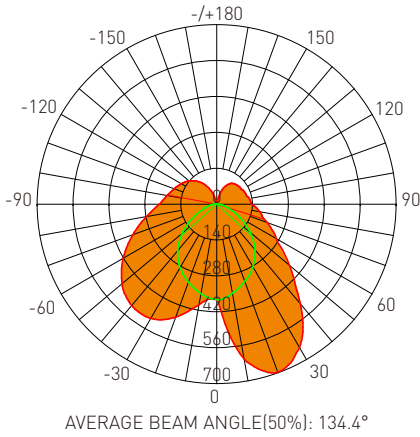

Test Number: LV4-ITW2F
 Lumens: 2513.51 Lm
 Watts: 20 W
 LPW: 128.60 Lm/W
 CCT: 3500K

UNIT: cd
 — C0/180,172.9°
 — C90/270,95.9°

Zonal Flux Diagram

τ	C0	C45	C90	C135	C180
10	611.9	529.4	353.2	372.8	398.2
20	696.7	605.3	321.0	405.9	469.0
30	646.1	587.6	282.2	434.1	514.3
40	507.3	499.5	233.0	434.4	516.3
50	370.0	396.0	170.6	406.3	482.6
60	268.7	307.9	105.5	362.4	421.9
70	210.5	241.7	52.89	308.1	347.6
80	170.9	192.0	21.38	254.4	278.2
90	136.0	150.2	3.729	208.8	224.7
100	129.3	141.9	0.7169	183.8	197.2
110	120.7	132.4	0	162.4	176.9
120	114.5	124.7	0	141.2	160.3
130	111.3	111.7	0	116.5	142.0
140	105.3	91.46	0	88.58	117.5
150	89.30	64.69	0	13.74	46.12
160	58.63	13.33	0	13.74	46.12
170	8.001	0.8131	0.0901	0.9910	3.441
180	0.2742	0.7223	0	0.5422	0.4570
DEG	LUMINOUS INTENSITY:cd				

Zonal Lumens

τ	φ total
0-10	39.83
10-20	172.8
20-30	397.3
30-40	682.1
40-50	983.6
50-60	1270
60-70	1524
70-80	1740
80-90	1916
90-100	2066
100-110	2195
110-120	2305
120-130	2392
130-140	2455
140-150	2494
150-160	2511
160-170	2513
170-180	2514
UNIT: lm	

Luminance cd/(m2)

G(DEG)	C0/180	C90/270
85	17757	1235
80	9862	1231
75	7136	1355
70	6166	1547
65	5669	1817
60	5384	2111
55	5481	2397
50	5768	2655
45	6108	2868

3' / 3500K

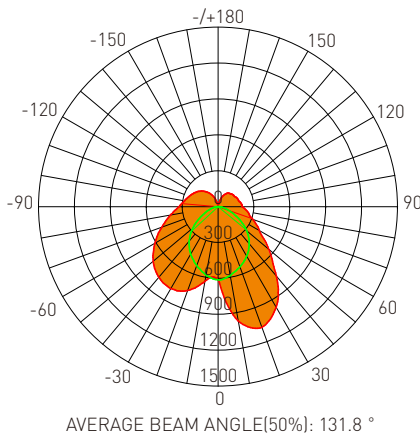

Test Number: LV4-ITW3F
 Lumens: 3805.84 Lm
 Watts: 30 W
 LPW: 129.55 Lm/W
 CCT: 3500K

UNIT: cd
 — C0/180,172.9°
 — C90/270,95.9°

Zonal Flux Diagram

τ	C0	C45	C90	C135	C180
10	968.4	858.3	586.1	597.8	633.0
20	1072	963.6	535.2	660.6	745.3
30	972.4	923.5	479.4	697.2	789.7
40	757.5	777.0	406.5	682.9	769.8
50	553.5	609.8	312.5	629.3	709.0
60	398.3	471.7	199.2	552.8	610.2
70	309.8	364.6	97.10	467.8	501.6
80	250.9	289.9	36.16	386.2	403.0
90	202.5	228.2	6.695	316.2	328.8
100	193.1	215.6	1.550	278.3	286.8
110	179.4	200.2	1.094	245.4	257.0
120	166.7	184.9	1.094	211.2	231.5
130	159.7	163.4	1.094	172.7	205.0
140	147.2	131.9	1.277	131.6	166.7
150	123.3	86.11	1.277	86.34	122.4
160	89.04	20.26	2.183	26.9	67.01
170	14.40	2.257	4.102	2.546	8.510
180	1.548	2.162	4.195	1.819	1.640
DEG	LUMINOUS INTENSITY:cd				

Zonal Lumens

τ	φ total
0-10	64.38
10-20	276.1
20-30	628.3
30-40	1069
40-50	1530
50-60	1963
60-70	2343
70-80	2662
80-90	2924
90-100	3147
100-110	3340
110-120	3502
120-130	3630
130-140	3721
140-150	3776
150-160	3801
160-170	3806
170-180	3806
UNIT: lm	

Luminance cd/(m2)

G(DEG)	C0/180	C90/270
85	26130	2103
80	14462	2074
75	10471	2379
70	9068	2827
65	8384	3404
60	7975	3967
55	8151	4462
50	8620	4840
45	9128	5102

META Surface-Pendant

Spec-grade | Vertical Architectural LED Linear Lighting



ILLUMINATING US

4' / 3500K

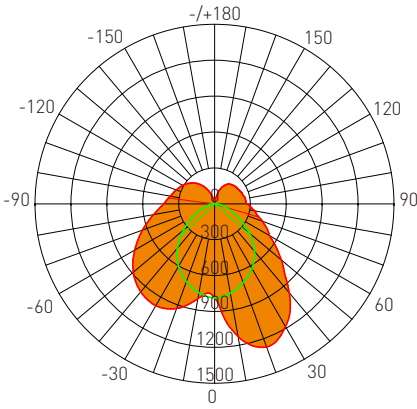

AVERAGE BEAM ANGLE(50%): 133.0°

Test Number: LV4-ITW4F
 Lumens: 4593.3 Lm
 Watts: 40 W
 LPW: 125.53Lm/W
 CCT: 3500K

UNIT: cd
 — C0/180,170.5°
 — C90/270,95.5°

Zonal Flux Diagram

τ	C0	C45	C90	C135	C180
10	1124	1022	758.9	760.8	803.3
20	1273	1138	701.6	829.5	929.4
30	1185	1112	606.1	866.8	983.1
40	973.0	958.4	519.0	842.6	961.5
50	729.5	773.1	379.3	774.9	887.5
60	531.8	612.2	230.6	686.5	770.2
70	426.6	486.9	117.9	585.1	640.8
80	340.1	390.7	50.83	486.0	519.1
90	269.6	309.6	9.746	399.4	426.1
100	259.8	293.4	1.830	352.8	377.8
110	247.9	274.0	1.542	312.7	342.5
120	236.4	254.7	1.541	268.5	310.9
130	227.1	227.3	1.540	219.2	271.1
140	213.0	184.6	1.599	164.2	221.8
150	184.7	114.4	1.665	102.2	158.7
160	125.8	49.61	1.731	33.69	82.85
170	34.73	13.20	2.806	3.606	13.88
180	2.040	3.092	2.889	2.495	1.943
DEG	LUMINOUS INTENSITY:cd				

Zonal Lumens

τ	φ total
0-10	79.88
10-20	340.0
20-30	774.2
30-40	1323
40-50	1904
50-60	2453
60-70	2941
70-80	3358
80-90	3702
90-100	3994
100-110	4251
110-120	4468
120-130	4639
130-140	4764
140-150	4839
150-160	4873
160-170	4881
170-180	4881
	UNIT: lm

Luminance cd/(m2)

G(DEG)	C0/180	C90/270
85	35045	3092
80	19601	2920
75	14272	3084
70	12484	3438
65	11396	3990
60	10646	4599
55	10947	5289
50	11358	5885
45	11738	6380